

THE RAWINDOW 22-24 LED

PDS22/PDS24/PDG22/PDG24/PDF22/PDF24

SPECIFICATION FEATURES

- HOUSING:** 20 gauge formed cold rolled steel housing with continuous seam welds. Aluminum and stainless steel option available.
- FRAME:** Inset extruded door available in anodized aluminum or white painted aluminum. Overlapping door frame available in aluminum, CRS, and stainless steel. Frame fastened to housing via aircraft cable.
- LENS:** Various graphic images available. See page 2 for options. Optional custom graphics. Overlapping frame uses a rail hold down system with silicone sealant.
- LED:** Available in four white color temperatures 3500°K, 4000°K, and 5000°K. Other color temperatures available, consult factory. 0-10V dimming available with 10-100% range. Must specify dimming under options.
- GASKET:** Closed cell PVC or extruded silicone gaskets prevent air contaminants from entering room.
- FASTENERS:** Philips flat head screws with captive cage nuts.
- FINISH:** White antimicrobial powder coat finish following an iron phosphate pre-treatment.



APPLICATION: Patient Rooms, Dental Offices, Waiting Rooms, Offices, Conference Rooms, and more.

MOUNTING: Surface, Grid and Flange install available. Flange fixtures come with adjustable 90° swing arm for easy installation.

LABEL: Fixture is certified to UL standards for Damp Location. Certified IP65, ISO4, and NSF.



ORDERING INFORMATION

Ex: PDF24-HC/IE-L4352C-RT-UN

PRODUCT FAMILY	MOUNTING	NOMINAL SIZE <small>*Dimensional Data Pg. 2</small>	HOUSING	FRAME Inset (I) or Overlap (O)	# OF LAMPS
PD	S = Surface G = Grid F = Flange	22 = 2x2 24 = 2x4	HC= 20Ga. CRS (standard) HS= 20Ga. SS (Brushed) HP= 20Ga. SS (painted) HA= .050Ga. Alum. (painted)	IE=Extruded Alum. ✓ IP=Extruded Alum. ✓ (Painted) IP65: IC=20Ga.CRS IA= .050 Alum. (Painted) IB=20Ga.S.S. (Brushed) IS=20Ga.S.S. (Painted) OC=18Ga.CRS (Standard) OS=18Ga.S.S (Brushed) OP=18Ga.S.S. (Painted) OA= .050 Alum. (Painted)	22: L4 = 4 Row (50W) L6 = 6 Row (75W) 24: L4 = 4 Row (100W) L6 = 6 Row (150W)
LAMP TYPE	CIRCUITS	IMAGE SELECTION <small>(See Image Options on Pg. 2)</small>	VOLTAGE	OPTIONS	
35 = 3500°K 40 = 4000°K 50 = 5000°K	1C = 1 Circuit 2C = 2 Circuits	RT = Red Flowers w. Tree PT = Palm Tree 1 WF = White Flower P2 = Palm Tree 2 TE = Tree BT = Blue Sky w Tree B1 = Blue Sky 1 B2 = Blue Sky 2 WT = White Tree WP = White Pink Tree YO = Yellow Orange Tree CI = Custom Image EL2 = Emerg. Bat. LED High (20W) Δ TH = Torx Head screws (with center pin) TM = Tandem Mount+	12 = 120V 27 = 277V 34 = 347V UN = Universal (120V-277V)	DM FZ* EL1 Δ EL2 Δ TH TM +	

KEY

DM = 0-10V dimming with 10-100% range
FZ = Fuse*
EL1 = Emerg. Bat. LED Low (10W) Δ

✓ Not IP65
* Cannot use with UN voltage
+ Consult factory
Δ Not available with 347V

Notes:
Specifications and Dimensions are subject to change without notice. If lamp type is not specified at time of quote or order, fixture will be set with 3500°K.
If circuit is not specified at time of quote or order, fixture will have single circuit.

DIMENSIONAL DATA

SURFACE MOUNTING

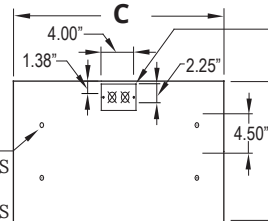
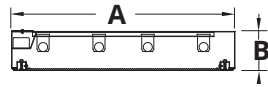

PDS22: (4) 7/16"
DIA. THRU HOLES
PDS24: (6) 7/16"
DIA. THRU HOLES

REMOVABLE COVER;
GASKETED TO
HOUSING WITH (2)
7/8" DIA. K.O.'S

GRID MOUNTING

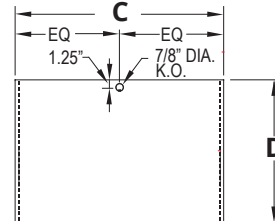
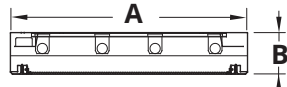

FLANGE MOUNTING

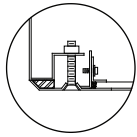
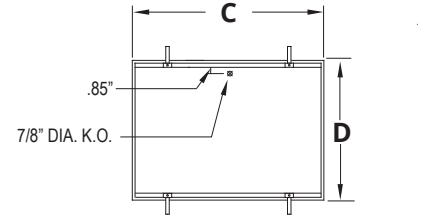
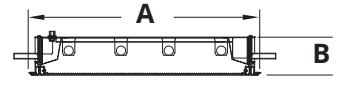

OVERLAPPING FRAME

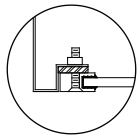

ALUMINUM EXTRUDED
INSET FRAME

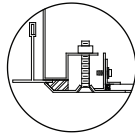

OVERLAPPING FRAME

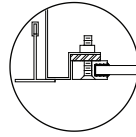

ALUMINUM EXTRUDED
INSET FRAME

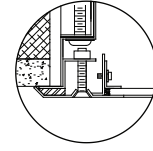

OVERLAPPING FRAME

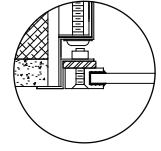

ALUMINUM EXTRUDED
INSET FRAME

	A	B	C	D	Recommended Ceiling Cut-Out
PDS22	24.00"	3.94"	24.07"	24.00"	N/A
PDS24	24.00"	3.94"	48.07"	24.00"	N/A
PDG22	23.69"	3.94"	24.20"	23.69"	N/A
PDG24	23.69"	3.94"	48.07"	23.69"	N/A
PDF22	25.25"	3.94"	25.25"	25.13"	24.375" x 24.375"
PDF24	25.25"	3.94"	49.13"	25.13"	48.375" x 24.375"

IMAGE SELECTION



RT = Red Flowers w Tree



PT = Palm Tree 1



WF = White Flower



P2 = Palm Tree 2



TE = Tree



BT = Blue Sky w Tree



B1 = Blue Sky 1



B2 = Blue Sky 2



WT = White Tree



WP = White Pink Tree



YO = Yellow Orange Tree



CI = Custom Image

Notes:
Specifications and Dimensions are subject to change without notice.
For additional options and dimensional details please consult your New Star Lighting Representative.

THE WINDOW 22-24 FLUORESCENT

PDS22/PDS24/PDG22/PDG24/PDF22/PDF24

SPECIFICATION FEATURES

- HOUSING:** 20 gauge formed cold rolled steel housing with continuous seam welds. Aluminum and stainless steel option available.
- FRAME:** Inset extruded door available in anodized aluminum or white painted aluminum. Overlapping door frame available in aluminum, CRS, and stainless steel. Frame fastened to housing via aircraft cable.
- LENS:** Various graphic images available. See page 2 for options. Optional custom graphics. Overlapping frame uses a rail hold down system with silicone sealant.
- ELECTRONICS:** Electronic ballast <10% THD standard. Lamps by others.
- GASKET:** Closed cell PVC or extruded silicone gaskets prevent air contaminants from entering room.
- FASTENERS:** Philips flat head screws with captive cage nuts.
- FINISH:** White antimicrobial powder coat finish following an iron phosphate pre-treatment.



APPLICATION: Patient Rooms, Dental Offices, Waiting Rooms, Offices, Conference Rooms, and more.

MOUNTING: Surface, Grid and Flange install available. Flange fixtures come with adjustable 90° swing arm for easy installation.

LABEL: Fixture is certified to UL standards for Damp Location. Certified IP65, ISO4, and NSF.



ORDERING INFORMATION

Ex: PDF24-HC/IE-4321C-RT-UN

PRODUCT FAMILY	MOUNTING	NOMINAL SIZE <small>*Dimensional Data Pg. 2</small>	HOUSING	FRAME Inset (I) or Overlap (O)	# OF LAMPS
PD	S = Surface G = Grid F = Flange	22 = 2x2 24 = 2x4	HC= 20Ga. CRS (standard) HS= 20Ga. SS (Brushed) HP= 20Ga. SS (painted) HA= .050Ga. Alum. (painted)	IE=Extruded Alum. ✓ IP=Extruded Alum. ✓ (Painted) IP65: IC=20Ga.CRS IA= .050 Alum. (Painted) IB=20Ga.S.S. (Brushed) IS=20Ga.S.S. (Painted) OC=18Ga.CRS (Standard) OS=18Ga.S.S (Brushed) OP=18Ga.S.S. (Painted) OA= .050 Alum. (Painted)	2 = 2 Lamps 3 = 3 Lamps 4 = 4 Lamps 6 = 6 Lamps
LAMP TYPE	CIRCUITS	IMAGE SELECTION <small>(See Image Options on Pg. 2)</small>	VOLTAGE	OPTIONS	
22: 14 = Lin 14W T5 17 = Lin 17W T8 24 = 24W T5 HO 24: 28 = Lin 28W T5 32 = Lin 32W T8 54 = Lin 54W T5 HO	1 = 1 Circuit 2 = 2 Circuits	RT = Red Flowers w. Tree PT = Palm Tree 1 WF = White Flower P2 = Palm Tree 2 TE = Tree BT = Blue Sky w Tree B1 = Blue Sky 1 B2 = Blue Sky 2 WT = White Tree WP = White Pink Tree YO = Yellow Orange Tree CI = Custom Image	12 = 120V 27 = 277V 34 = 347V ■ UN = Universal (120V-277V)	DB* TH SDM TM+ PR E1* ◀ FZ* E2* ◀	

KEY

DB = Dimming Ballast (0-10V)*
SDM = Step Dimming Module
PR = Program Rapid Start
FZ = Fuse*

Notes:

Specifications and Dimensions are subject to change without notice.

For additional options and dimensional details please consult your New Star Lighting Representative.

TH = Torx Head screws (with center pin)
TM = Tandem Mount +
E1 = Emerg. Battery Pack (450 Lumens)* ◀
E2 = Emerg. Battery Pack (1100 Lumens)* ◀

✓ Not IP65

■ Consult factory for lamp-ballast options

* Cannot use with UN voltage

◀ Consult factory for T5 availability

+ Not available with Grid

THE RAW WINDOW 22-24 FLUORESCENT

PDS22/PDS24/PDG22/PDG24/PDF22/PDF24



DIMENSIONAL DATA

SURFACE MOUNTING

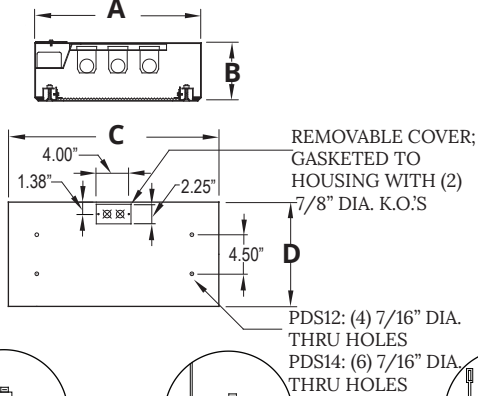

GRID MOUNTING

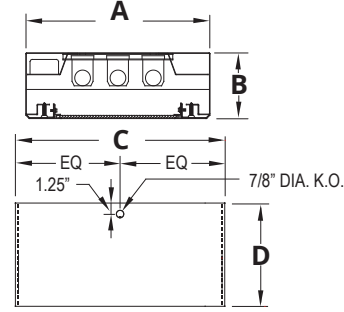

FLANGE MOUNTING

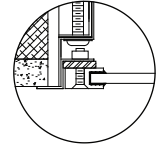
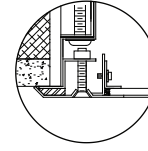
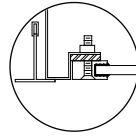
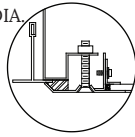
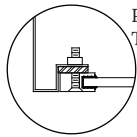
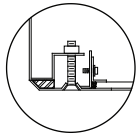
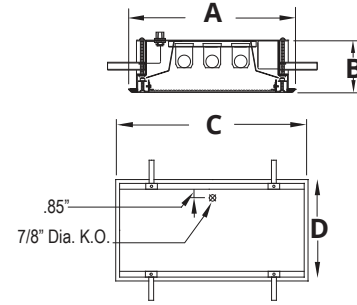

OVERLAPPING FRAME

ALUMINUM EXTRUDED INSET FRAME

OVERLAPPING FRAME

ALUMINUM EXTRUDED INSET FRAME

OVERLAPPING FRAME

ALUMINUM EXTRUDED INSET FRAME

	A	B	C	D	Recommended Ceiling Cut-Out
PDS22	24.00"	3.94"	24.07"	24.00"	N/A
PDS24	24.00"	3.94"	48.07"	24.00"	N/A
PDG22	23.69"	3.94"	24.20"	23.69"	N/A
PDG24	23.69"	3.94"	48.07"	23.69"	N/A
PDF22	25.25"	3.94"	25.25"	25.13"	24.375" x 24.375"
PDF24	25.25"	3.94"	49.13"	25.13"	48.375" x 24.375"

IMAGE SELECTION



RT = Red Flowers w Tree



PT = Palm Tree 1



WF = White Flower



P2 = Palm Tree 2



TE = Tree



BT = Blue Sky w Tree



B1 = Blue Sky 1

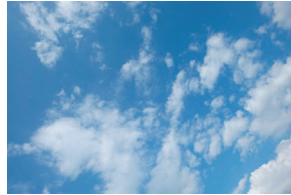

B2 = Blue Sky 2



WT = White Tree



WP = White Pink Tree

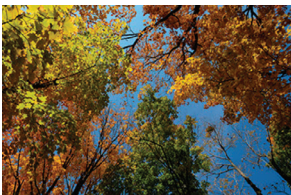

YO = Yellow Orange Tree



CI = Custom Image

Notes:

Specifications and Dimensions are subject to change without notice.
For additional options and dimensional details please consult your New Star Lighting Representative.