

MRI STARTILE VARA KAMIN'S IMPRESSIONS OF LIGHT®, INC. 11-14 LED
AGS11/AGS14/AGG11/AGG14/AGF11/AGF14

SPECIFICATION FEATURES

HOUSING: Fixture Frame White Extruded Aluminum. Non-ferrous material. Surface fixtures have an aluminum back pan. Flange fixtures have an external frame in aluminum.

LENS: Images are from Vara Kamin's Impressions of Light® Inc. (VKI). VKI Images are rich in color, movement and texture. Kamin's artwork stimulates the active imagination and invites the viewer to a place of self-reflection. To find more information, visit www.newstarlighting.com. Configuration options on pages 3 and 4. Surface and Flange fixtures are unavailable in certain configurations, consult factory for options.

LED: Recommended color temperature for VKI Images is 4200°K. Other color temperatures available, consult factory. Standard 0-10V dimming driver with 10-100% range.

POWER SUPPLY: LED Driver Included. Driver must be remote mount outside of MRI room. MRI room EMI filter required (supplied by others).
Input Voltage: AC120V-277V
AG11: Input Power 18.0W (must order Power Supply separately. See page 2)
AG14: Input Power 40.0W (must order Power Supply separately. See page 2)



APPLICATION: MRI Rooms.

LABEL: Fixture is certified to UL standards for Damp Location.



ORDERING INFORMATION

Ex: AGS11-MRI-VMD-UN-42-A

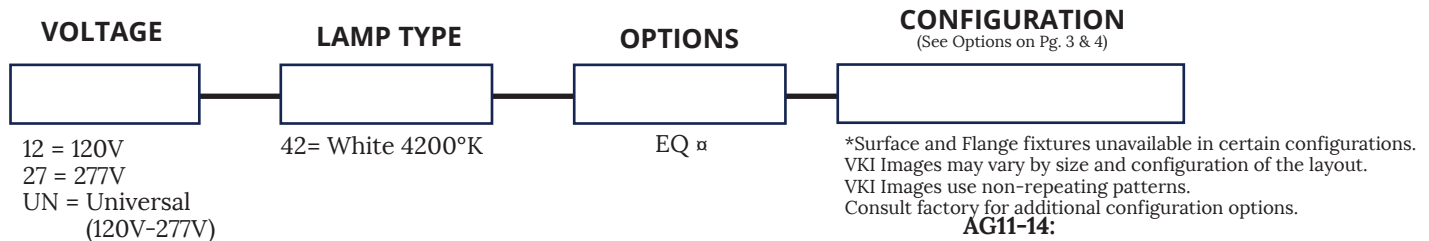
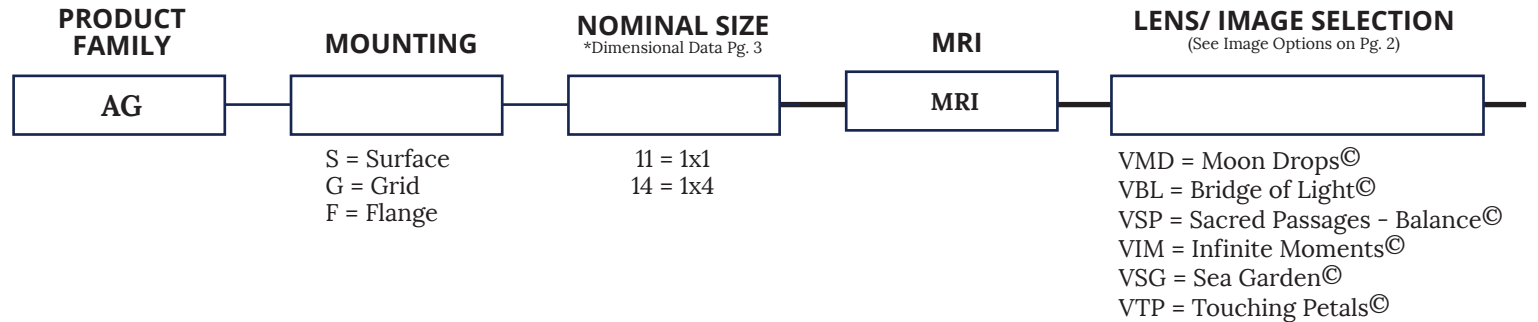

KEY

EQ = Earthquake Clips ☐ ☐ Can only be used with Grid

- AG11-14:**
A F
B G
C H
D I
E

Notes:
Image is Vara Kamin's Impressions of Light®, Inc. Moon Drops® (VMD)
Specifications and Dimensions are subject to change without notice.
For additional options and dimensional details please consult your New Star Lighting Representative.

REMOTE POWER SUPPLY ORDERING INFORMATION

StarTile MRI fixtures supplied with LED Driver. Driver must be remote mount outside of MRI Room.
 One Driver inside one Box to power one fixture (maximum).
 MRI room EMI filter required (supplied by others).
 Consult factory for additional Power Supply Box options.

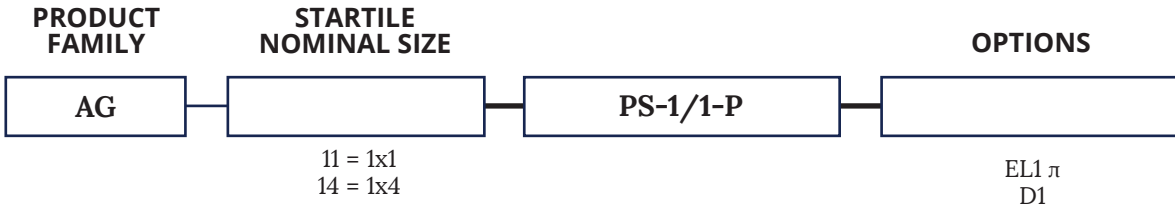

KEY

EL1 = Emerg. Batt. LED Low π
 D1 = Dimming Driver 1%

π Remote battery distance equals half the remote driver distance. Consult factory for more information.

VKI IMAGE SELECTION

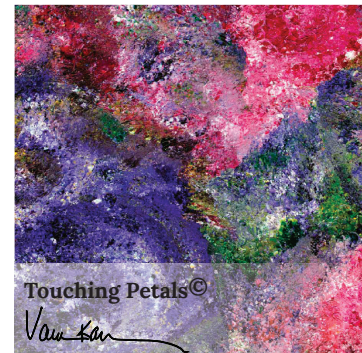
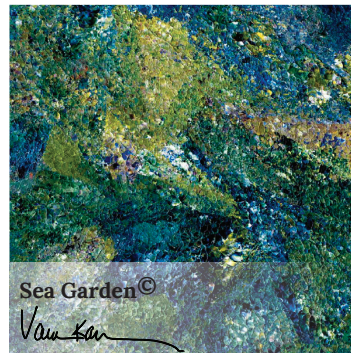
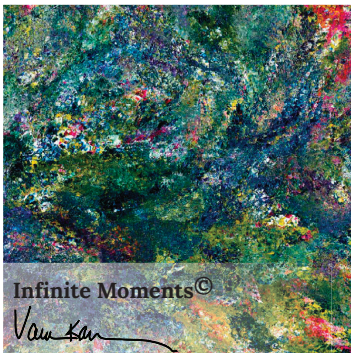
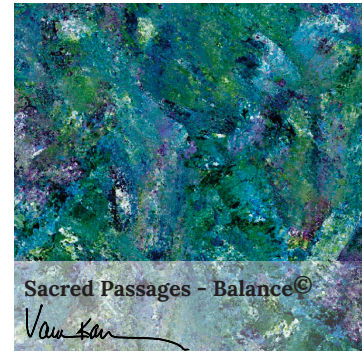
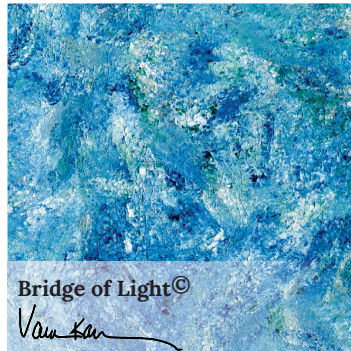
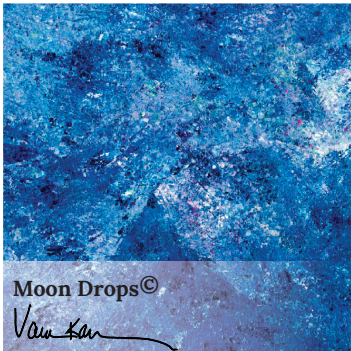

Notes:

VKI Images may vary by size and configuration. Consult your New Star Lighting Representative for more information.
 Specifications and Dimensions are subject to change without notice.
 For additional options and dimensional details please consult your New Star Lighting Representative.

DIMENSIONAL DATA

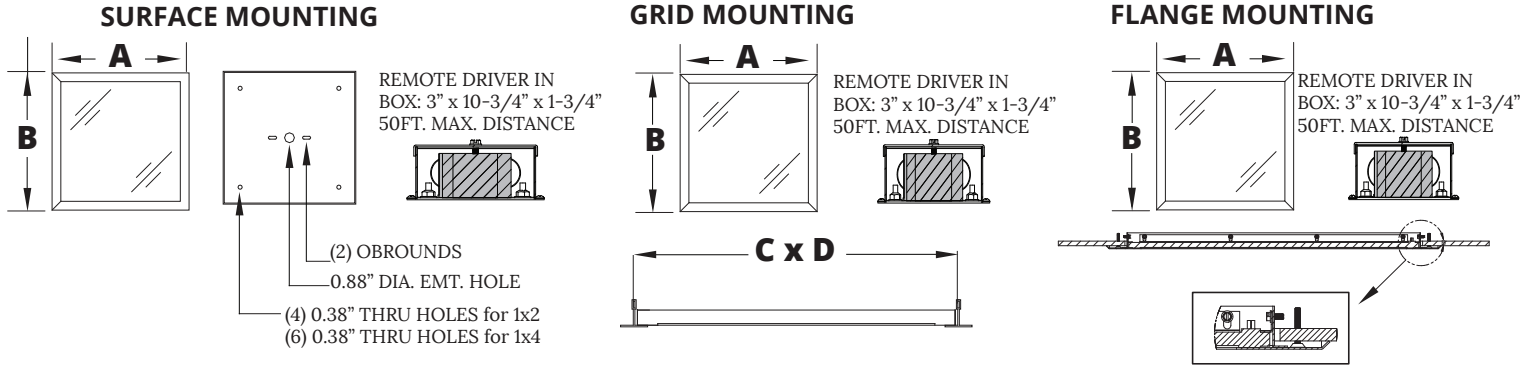

	A	B	C	D	Depth	Recommended Ceiling Cut-Out
AGS11	12.00"	12.00"	-	-	1.00"	N/A
AGS14	12.00"	47.375"	-	-	1.00"	N/A
AGG11	11.81"	11.81"	12"	12"	0.56"	N/A
AGG14	11.81"	47.75"	12"	48"	0.56"	N/A
AGF11	15.50"	15.50"	-	-	1.30"	12.483" x 12.438"
AGF14	15.38"	50.813"	-	-	1.30"	12.438" x 47.1875"

CONFIGURATION OPTIONS

* Surface and Flange fixtures unavailable in certain configurations. VKI Images may vary by size and configuration of the layout. VKI Images use non-repeating patterns. Consult factory for alternate configurations. Images may need to be edited based upon configuration and quantity.

1' x 1'	A	B	C	D	E	F	G	H	I
	1	1 2	1 2	1					
		3 4		2					
E	1 2 3 4								
					F	G			
					1 2	1 2 3 4			
H					3 4	5 6 7 8			
	1 2 3 4				5 6		I		
	5 6 7 8				7 8		1 2 3		
	9 10 11 12						4 5 6		
	13 14 15 16						7 8 9		

Notes:

VKI Images may vary by size and configuration of the layout. Consult your New Star Lighting Representative for more information. Specifications and Dimensions are subject to change without notice. For additional options and dimensional details please consult your New Star Lighting Representative.

CONFIGURATION OPTIONS

* Surface and Flange fixtures unavailable in certain configurations. VKI Images may vary by size and configuration of the layout. VKI Images use non-repeating patterns. Consult factory for alternate configurations. Images may need to be edited based upon configuration and quantity.

1' x 4'									
	A		B			C			
	1		1	2		1	2		
			3	4					
	D								
	1		E						
	2		1	2	3	4			
	F			G					
	1	2		1	2	3	4		
	3	4		5	6	7	8		
	5	6							
	7	8							
	H					I			
	1	2	3	4		1	2	3	
	5	6	7	8		4	5	6	
	9	10	11	12		7	8	9	
	13	14	15	16					

Notes:
 VKI Images may vary by size and configuration of the layout. Consult your New Star Lighting Representative for more information.
 Specifications and Dimensions are subject to change without notice.
 For additional options and dimensional details please consult your New Star Lighting Representative.